

# PD6310-WM / PD8-6310-WM NTEP® Certified Pulse Input Batch Controllers

## Data Sheet



### COMMON FEATURES

- Pulse, Open Collector, NPN, PNP, TTL, Switch Contact, Sine Wave (Coil), Square Wave Inputs
- Dual-Line 6-Digit Display, 0.60" & 0.46" Height
- Input Power Options Include 85-265 VAC or 12-24 VDC
- 5, 10, or 24 VDC Flowmeter Power Supply
- 2 or 4 Relays + Isolated 4-20 mA Output Options
- Modbus® RTU Communication Protocol Standard
- K-Factor, Internal Scaling, or External Calibration
- Onboard USB and MeterView Pro Programming Software

### PROVU® PANEL MOUNT FEATURES

- Standard 1/8 DIN Mounting
- NEMA 4X, IP65 Front
- Optional SunBright Display Models for Outdoor Applications

### COMMON BATCH CONTROLLER FEATURES

- Single or Multi-Stage Batch Control
- Automatic or Manual Batch Control
- Start / Pause / Stop, Change Batch with Front Panel Buttons
- Automatic Overrun Correction
- Count Up or Down with Each Batch
- Display Batch Total, Rate, Grand Total, Count or Preset
- Rate in Units per Second, Minute, Hour, or Day
- 9 Digit Grand Total with Overflow Feature
- Low or High Flow Alarms while Batching

### PROTEX-MAX EXPLOSION-PROOF FEATURES

- Fully Approved Explosion-Proof Pulse Input Batch Controller
- Explosion-Proof, IP68, NEMA 4X Enclosure Available in Aluminum or Stainless Steel
- Display Mountable in 90 Degree Increments
- SafeTouch Through-Glass Programming
- Flanges for Wall or Pipe Mounting
- CSA Certified as Explosion-Proof / Dust-Ignition-Proof / Flame-Proof
- ATEX and IECEx Certified as Dust-Ignition-Proof / Flame-Proof

**FLUIDPRO**

Dosing Systems

[www.fluidprodosingsystems.com.au](http://www.fluidprodosingsystems.com.au)

QLD 07 3071 7415 NSW 02 8069 2664 VIC 03 9021 6624

**PRECISION DIGITAL CORPORATION**

**PRECISION  
DIGITAL**

[www.predig.com](http://www.predig.com)

# PD6310-WM / PD8-6310-WM NTEP® Certified Batch Controllers



UV Resistant  
Sunlight Readable Display



Front Panel  
NEMA 4X Rated



MeterView Pro

USB Install



## INTRODUCTION

The PD6310-WM and PD8-6310-WM are NTEP® Certified, pulse input single or multi-stage batch controllers certified as Weighing and Measuring Devices. These versatile NTEP Certified batch controllers are not only ideal for Weights and Measures batching applications, but provide reliable, cost-effective, independent batch control operation where local control is preferred to expensive systems with a much larger footprint. The PD6310-WM is a panel mount NTEP Certified batch controller and the PD8-6310-WM is an explosion-proof NTEP Certified batch controller.

The specifications and operation of the panel mount and explosion-proof versions of these batch controllers is very much the same. The main difference is the rating of the flowmeter power supply. These batch controllers have a mechanically secured, tamper-proof, programming lockout feature that consists of a cable with a compression seal that is used to prevent access to the programming lockout jumper.

**NTEP®  
Certified Wire  
Security Seal**  
Prevents access to  
the programming  
lockout jumper

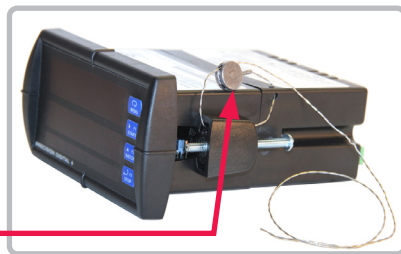

Programming and operating these batch controllers is done via front panel start, pause, stop, and batch size buttons. As an added benefit, The PD8-6310 explosion-proof batch controller's Safe-Touch buttons allow it to be programmed without removing the cover, making it easy and economical to change batch sizes in hazardous areas.

The high intensity, sunlight readable, dual-line display makes it possible to locate these batch controllers outdoors in direct sunlight and display a variety of useful information. For instance the upper display could show the running batch total and the lower display could show the batch size.

Free PC-based MeterView Pro software allows these batch controllers to be programmed and operated via a computer.

## INTUITIVE BATCH CONTROL

The front panel has intuitive buttons and displays that make operating the batch controller clear and easy right out of the box. START, BATCH, and STOP buttons come setup by default for batch controller operation. The START button is used to begin a batching process. The BATCH button is used to quickly access the preset value. The STOP button can be pressed once to pause a batch, or twice to cancel a batch in progress. The upper and lower displays can be easily configured for your application need. The STOP button may be used to easily cycle the lower display information while the batch is stopped.

## Easily Choose Your Display Information



### Batch Total & Preset

The preset on the lower display provides even quicker access to the preset menu just by using the arrow keys to change the value.



### Batch Total & Rate

The rate on the lower display may be alternated with units for variable flow batching systems. Rate alarms may also be used during the batch process.



### Batch Total & Batch Count

The batch count on the lower display, tracks completed batches. The count may be set back to 0 with the reset menu.



### Batch Total & Grand Total

A grand total with overflow digits for up to a 9 digit total may be displayed in the lower display, with password protection and non-resettable programmable features.

## Clearly Labeled Alternating Displays



**Batch Total & Preset**

**Alternating Display**

The upper display alternates the display to show the batch controller state when in pause or stop mode. When displaying rate, grand total, batch count, or preset, the lower display alternates between the display value and the function or unit of measure.

## Grand Total Displays Up to 9 Digits

These batch controllers can display up to nine digits of total flow with the grand total feature. In the diagrams below, the batch controller is displaying 532,831,470 by toggling between a display of "GF 532" and "831470". Notice the (GT with arrow ▲ symbol) is lit up indicating the display is in a grand total overflow mode.



## K-Factor Calibration

The PROVU batch controller may be calibrated using the K-Factor function. The batch controller will automatically calculate the flow rate using the K-Factor (usually supplied by the flowmeter manufacturer) and the time base selected.



**Input Setup**

**Display Setup**

## BATCH CONTROLLER CAPABILITIES

An NTEP Certified batch controller can be programmed for a wide variety of applications. Setup is easy for single or multi-stage batching. Automatic overrun correction keeps the batch size accurate, even over time and with system wear. It can record grand total, or non-resettable grand total with a time base of seconds, minutes, hours or days. The user can program a conversion factor, and configure a non-resettable grand total, and password protection.

## Single and Multi-Stage Batching

The unit can be used as a single or multi-stage batch controller. Relays assigned to the total act as batch control relays, with additional relays beyond the first including a preclose value. The preclose deactivates the relay before the batch is finished, to allow slower fill rates and a more accurate batch finish. With expansion module relays available only on the PROVU, up to eight-stage batching is possible. Each additional stage batching relay has an individually programmable preclose amount.

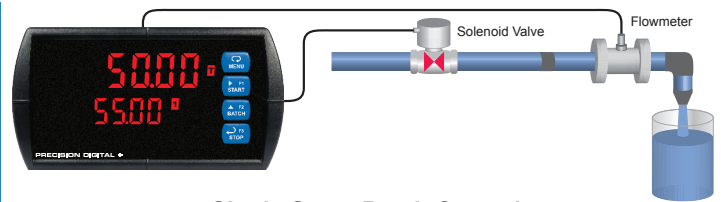

**Single Stage Batch Control**

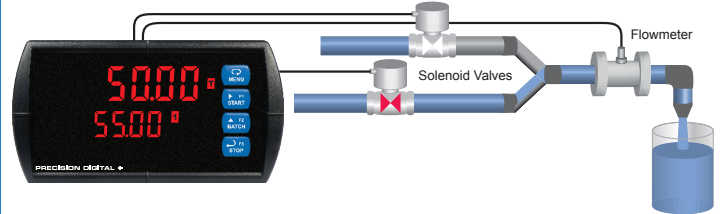

**Multi-Stage Batch Control**

## Manual or Automatic Batch Control

Batches may be started manually with the START front panel button, or with a remote digital input trigger. Batches may also be programmed to start automatically after a 0 to 999.9 second delay after the end of the last completed batch. A manually stopped batch will not automatically restart. The START button or digital input must be used.

## Automatic Overrun Correction

The NTEP Certified batch controller will correct for batch overrun or shortages automatically. By tracking the amount the batch was off by, the batch controller will automatically adjust the batch by modifying the batch relay deactivation time.

## Quick Preset Changes



The front panel BATCH key is configured by default to access the preset menu. The preset may be changed quickly and easily between batches without the need to enter setup menus.

## Non-Resettable Grand Total

The user can set up the grand total to be non-resettable by entering a specific password. Once this is done, the grand total can never be reset.

## Total Conversion Factor

The user can enter a conversion factor that allows the batch controller to display total in different units than the rate. For instance, an operator could measure flow rate in gallons per minute and grand total in hundredths of acre-feet.

## Grand Total & Rate Alarms

The unit's four relays can be set up to alarm when the grand total reaches a user-defined set point or when the rate is above or below a certain value. Rate alarms are only activated when the batching process is running. A variety of reset modes are available and the user can also program time delays and fail-safe operation.

## On-Board Digital Input for Remote Operation

The NTEP Certified batch controller includes a digital input as standard. This digital input, labeled F4, can be used for remote operations such as resetting the total. The digital input can operate with the interlock relays feature, force relays on from a signal from a PLC or relay on other equipment, display Max or Min flow rates, and much more. This is ideal for installations where the meter is inaccessible behind a cover, or where an additional function key is needed for customized operation.

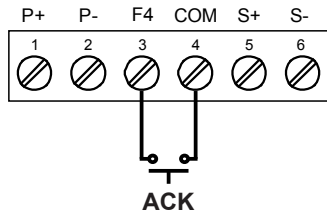

## Rounding

The rounding feature is used to give the user a steadier display with fluctuating signals. It causes the display to round to the nearest value according to the rounding value selected (1, 2, 5, 10, 20, 50, or 100). For example, with a rounding value of 10, and an input of 12346, the display would indicate 12350.

## Standard SunBright LED Display

The ProVu PD6310-WM and ProtEX-MAX PD8-6310-WM include a SunBright display that features extraordinarily bright LEDs. They are perfect for indoor and outdoor applications where visibility may be impaired by smoke, fog, dust, distance or even direct sunlight.

## Four Types of Password Protection

The NTEP Certified batch controller offers 4 types of password protection. Level 1 protection allows the operator use of only the 3 pre-configured function keys on the front panel without a password. Level 2 protection allows the operator use of only the function keys and the ability to change set points without a password. Level 3 protection restricts the function keys and all configuration menus without a password. Finally, Grand Total Reset Protection prevents the total from being reset manually.

## OUTPUTS

### Relay Outputs

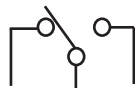

The batch controller has up to four 3 A Form C relays (SPDT) with multiple programmable functions. One (relay 1) should always be used for batch control. Other relays may be configured as additional batch relays, with or without preclose for multi-stage batching or as alarms for the rate or grand total. Each alarm has multiple power loss fail-safe options. Alarm relays can be configured for proper protective action upon input loop break. Alarm relay ON and OFF delay times are user adjustable. Up to eight front panel indicators show alarm and/or relay state. All alarm relays can be configured for 0-100% deadband. Rate alarms are only active while a batch is running.

## Relay Operation/Configuration

There are powerful relay functions that can be configured in the NTEP Certified batch controller, including:

- Single and multiple stage batch control with preclose
- Manual and automatic batch control modes
- Rate alarms during batch process
- Grand total alarms
- Sampling function
- User selectable fail-safe operation
- Time delay (on and off), independent for each alarm relay

## Analog Output

The isolated analog retransmission signal can be configured to represent the batch total, grand total, maximum (peak) value, minimum (valley) value, the value for any of the relay set points, manual setting control, or Modbus input. While the output is nominally 4-20 mA, the signal will accurately accommodate under- and over-ranges from 1 to 23 mA.

## Isolated Transmitter Power Supplies

A powerful 24 V @ 200 mA power supply is a standard feature on the ProVu NTEP Certified batch controller; the PD8 model's power supply is rated at 25 mA max. It can be configured for 5, 10, or 24 V (default) by means of a simple internal jumper. An additional power supply (for ProVu: 24 V @ 40 mA; for ProtEX-MAX: 24 V @ 25 mA) is standard with the 4-20 mA output option.

## DIGITAL COMMUNICATIONS

### Modbus® RTU Serial Communications

NTEP Certified batch controllers can communicate with any Modbus Master device using Modbus communications protocol. RS-485 connections come standard on the PD8; the PD6310-WM models require the purchase of a serial communication adapter. Below are some examples of other things that can be done with the unit's Modbus communications feature.

- Start, pause, stop, or change preset values
- Send a 6-character message to the lower display upon an event
- Remote user control (i.e. change set points, acknowledge alarms)
- Read rate, total, grand total, batch count, etc.



Modbus PV Input



Remote Message

## FIELD EXPANSION MODULES

Add functionality to the PD6310-WM ProVu NTEP Certified batch controller in the field with easy-to-install external expansion modules. Add USB, RS-232, or RS-485 communications, I/O modules, and 4-relay expansion module. **Note:** Not compatible with PD8 models.

## MANUAL MULTI-STAGE BATCH CONTROL OPERATION

### System Setup

Both valves are closed with an empty barrel in place. The batch total is displayed in the upper display, the preset is selected for the lower display.

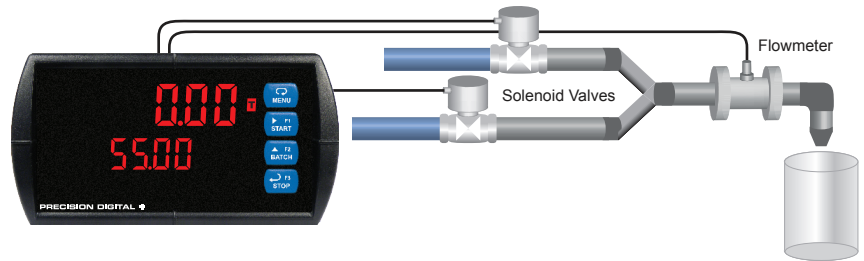

### Batch Start

The START button is pressed. Both valves open. The barrel begins to fill.

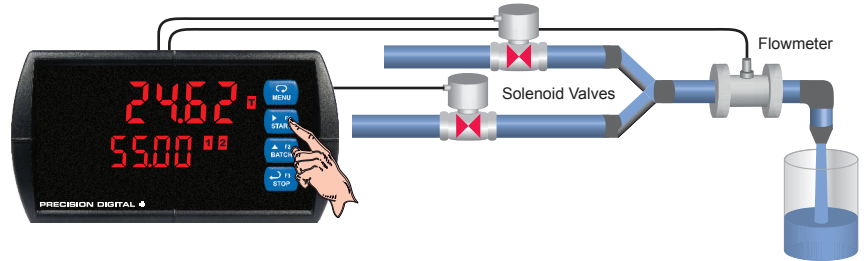

### Preclose Valve

When the batch total reaches a value of 50.00 (Preset [55.00] – Preclose [5.00]) the full-flow valve closes. The fill rate of the tank slows as a result.

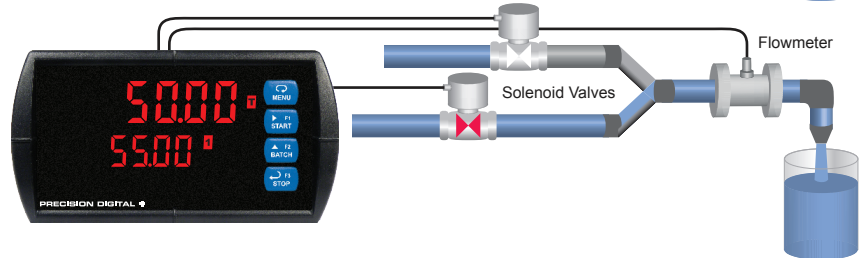

### Completed Batch

When the batch total equals the preset amount, the restricted-flow valve closes. The barrel is now full. If some overrun occurs, the next batch will adjust for this offset amount to maintain accuracy.

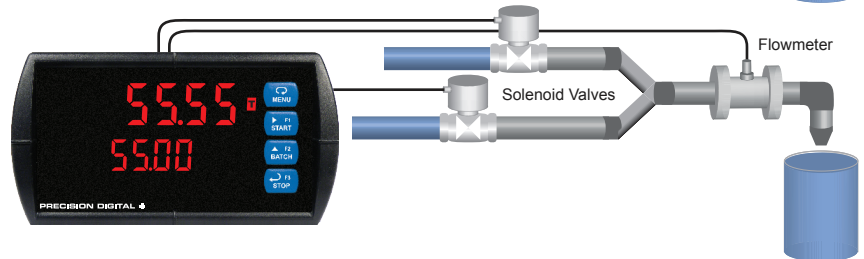

### Change Preset

After placing a new, empty barrel, a new preset fill amount may be selected with the Batch key, while the process is stopped.

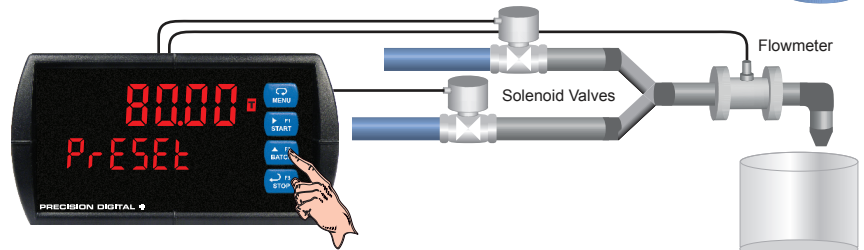

### Begin New Batch

Press the START key and a new batch will begin. With both valves open, the process continues.

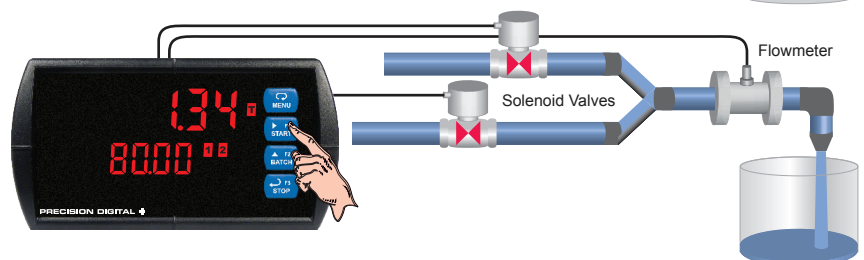

### Pause/Stop

At any time, the STOP button may be pressed, once to Pause the process, once to cancel the batch, which stops the process.

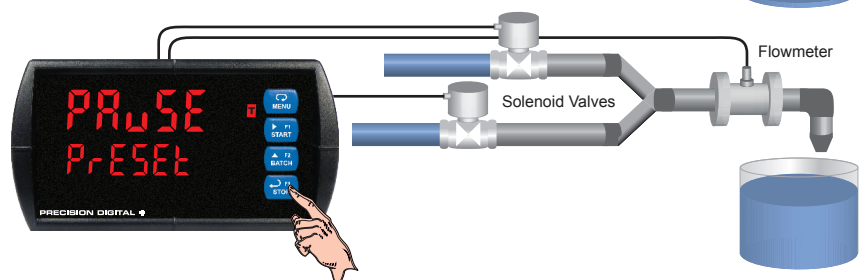

## PD8-6310-WM OVERVIEW

The explosion-proof NTEP Certified batch controller (PD8-6310-WM) has been designed to offer the functions and features of the ProVu PD6310-WM as a fully approved explosion-proof product. The PD8-6310-WM is not just an 1/8 DIN meter mounted in an explosion-proof housing. A special bezel and electronics were designed exclusively for the PD8-6310-WM. The bezel and faceplate house the additional electronics for the PD8. The PD8's interior case is secured with an NTEP Certified wire seal. The PD8's explosion-proof display is rotatable in 90 degree increments to ensure information remains visible in any mounting configuration.

### Program Batch Controller without Removing the Cover

The ProtEX-MAX explosion-proof NTEP Certified PD8-6310-WM Batch Controller is equipped with four infrared sensors that operate as through-glass buttons so that it can be programmed and operated without removing the cover in a hazardous area, keeping the electronics protected and secure. These SafeTouch buttons can be disabled for security by selecting the DISABLE setting on the switch, located on the connector board in the base of the enclosure. To actuate a button, press one finger to the glass directly over the marked button area. When the cover is removed, the mechanical buttons located on the faceplate can be used. PD8-6310-WM models with integrated ProVu functionality have a 10-position terminal block for connecting the digital inputs and outputs. See the PD8 Connection Drawing on page 9.



### Rugged, Heavy-Duty Enclosure

The ProtEX-MAX is housed in a rugged NEMA 4X, 7, & 9, IP68 aluminum or stainless steel enclosure, designed to operate over a wide temperature range (-55° to 65°C / -67° to 149°F) and to withstand harsh environments in safe and hazardous areas.

### Connections

To access the connectors, remove the enclosure cover and unscrew the two captive screws that fasten the electronics module. Signal connections are made to de-pluggable connectors on the back of the electronics module. Some connectors may be provided already connected. These connections are required for proper operation of the ProtEX-MAX, and should not be removed unless instructed. Grounding connections are made to the two ground screws provided on the base - one internal and one external. After all connections have been completed and verified, apply power to the unit.

### Remote Operation of the Batch Controller

The PD8-6310-WM includes 4 digital inputs. These digital inputs are preconfigured at the factory to function as external contacts to duplicate the front button functions of the instrument. The factory configuration uses the following corresponding digital input terminals for external switch contacts.

- I1=MENU
- I2=RIGHT Arrow=START
- I3=UP Arrow=BATCH
- I4=ENTER Arrow=STOP

These contacts can be wired up to a remote Control Station to handle programming and to operate the batch controller remotely such as the control button station shown on the right.



### Rotatable Display

The PD8-6310-WM's display can be rotated in 90 degree increments so you don't have to read critical information upside down or sideways. The built-in mounting flanges make for convenient wall or pipe mounting and there is even a slot on the back of the enclosure for centering on the pipe. There are four 3/4" NPT conduit holes for wiring.



### Digital I/O

The explosion-proof NTEP Certified batch controller has four digital inputs (I1-I4) and four digital outputs (O1-O4) standard.

The four digital inputs can function similarly to the front panel function keys, and are activated by a closed contact, transistor closure, logic level signal, or with the SafeTouch Through-Glass Buttons. They are configured at the factory to allow through-glass or remote control of the batch controller.

Digital outputs can be used to monitor alarm conditions, indicate relay alarm acknowledgement, or mimic the batching relay states for remote indication of the batching relay states.

## METERVIEW® PRO SOFTWARE

### Free USB Programming Software & Cable

The PROVu and ProtEX-MAX™ Batch Controllers come preloaded with free **MeterView® Pro** programming software that connects and installs directly to your PC with a standard USB cable, also provided free with each instrument. This eliminates the need to insert CDs, install drivers, or download software from the internet. The software will allow you to configure, monitor, and datalog a PD6310-WM OR PD8-6310-WM using your PC. Just simply connect the batch controller to your PC with the USB cable and within minutes you will be programming it.

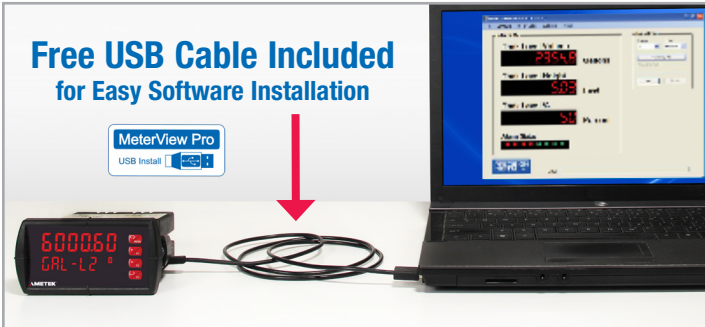

MeterView Pro makes complete meter configuration simple and fast. MVP's linearization feature makes even a 32-point linearization task clear and easy to do. We also included a basic meter monitor and datalogger. Of course, with the batch controller's powerful Modbus protocol, custom programs can be made even more versatile.

### Fully Program the Batch Controller

All the programming parameters of the batch controller may be configured from MeterView Pro Software. The configuration file may be saved for later use, and saved configuration files may be loaded into the software for download into the Batch Controller.

### Communications Setup

For initial communications setup of MeterView Pro, simply select the meter type, by model (i.e. PD6310), and make sure that the communication port on the computer is ready, indicated by the status box. To set up the communication port, click PC Port Setup at the top of the window, which will bring the user to the MeterView Serial Setup window. The operator plugs the data into the appropriate boxes via drop-down menus for Com Port, Meter Address, Baud Rate, and Parity.

**Note:** Baud Rate and Parity must match with those of other devices when using Modbus, otherwise communication breaks may occur.

### Setup

Within the main/configure window of MeterView Pro, select the Setup Tab to select the Input Type and Decimal Point, as well as enable/disable total/grand total flow measurement. Display parameters for Upper and Lower Displays, such as engineering units, are entered here, along with a display intensity value (8 being the brightest setting). Analog Outputs are scaled and tested here as well, using both display values and output values to translate the 4-20 mA signal. Relays can be set to force on, or set for automatic operation.

Communications Setup

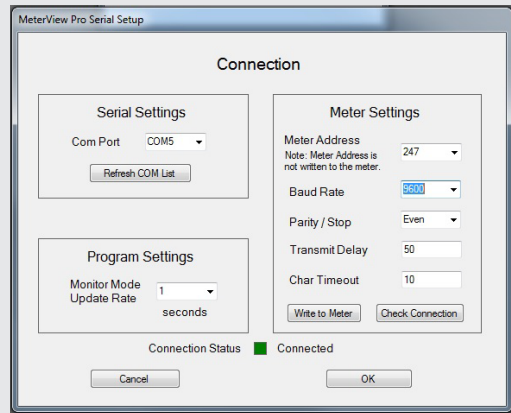

Setup

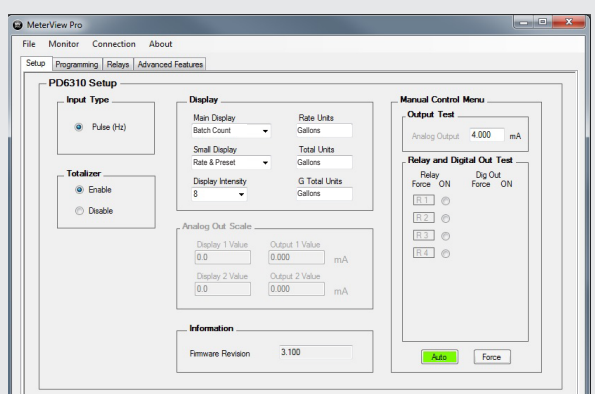

Relays

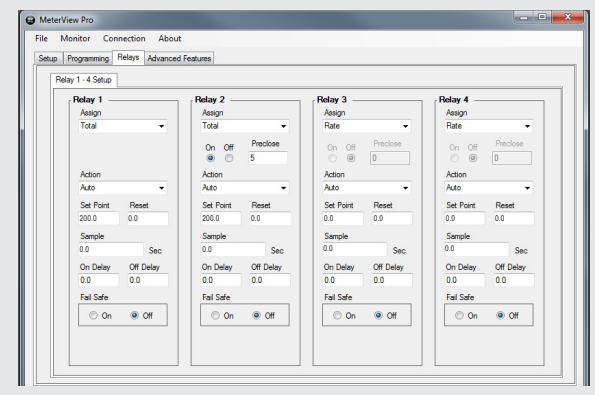

### Batch Control From a Computer

Through MeterView Pro Software, the preset and relay 2 preclose may be easily changed from the main control window shown here. The total and grand total may be reset with just the click of a button. The batch controller may be started, paused, and stopped through the control window, for full featured batch controller operation.

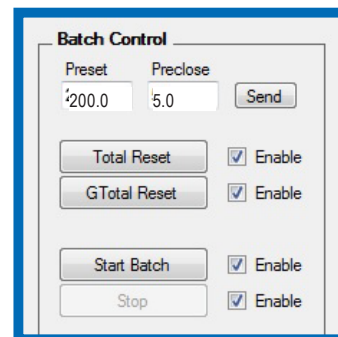

## Relays

Use the Relays Tab in MeterView Pro to independently program each relay. Actions can be set for each relay, and certain parameters pertain to each selection. Sample time can be entered for batch sampling. Set and reset points, as well as delay times for each relay, can be entered for specific applications. Fail Safe can be enabled/disabled for each relay. Actions can also be set for Input Break conditions at this level.

## Programming

Through MeterView Pro Software, operators can independently scale the meter's inputs using the Programming Tab. MeterView Pro contains a linearization feature that is helpful for flowmeters with non-linear outputs. First, enter the number of linearization (PV/Rate) points, from 1-32.

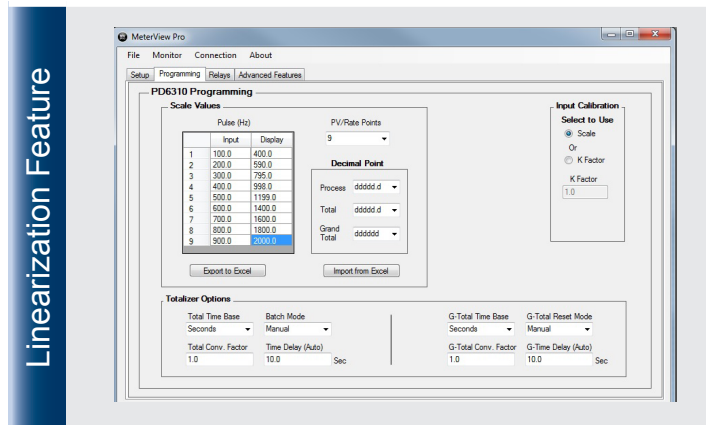

Then, in the corresponding window for each input, enter both the input values and the display values for each of the points. Once the appropriate data has been entered, the meter will display the proper flow information. Linearization data can be exported to or imported from Microsoft Excel. This window is also used to program the K-Factor.

## Advanced Features

Through the Advanced Features menu in MeterView Pro Software, the operator is able to program a variety of items pertaining to Inputs, Outputs, Function Keys, and General Operation. For all Function Keys and Digital Outputs, parameters are set under the User Menu for a number of variables, including Alarms, Acknowledgement, Set/Reset, and more.

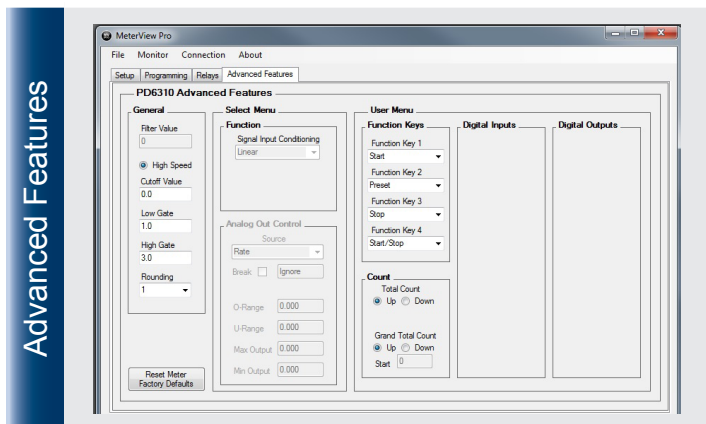

## Monitor & Datalog

Once the operator has entered all the necessary data for programming, MeterView Pro enables full monitoring of the meter, accessed by clicking Monitor at the top toolbar. The example here depicts the monitoring of the Current Batch, Batch Preset (Size), and Overall Batch Total. Alarm Status is clearly indicated by the green and red blocks numbered for each relay. Log Settings are entered by Interval and Time Base Unit. Data Logging can be started and paused in this location. Through MeterView Pro Software, the user is able to save the datalog report to the computer's C:/ Drive using the "Save Log As" button. The log can be retrieved and/or printed at any time.

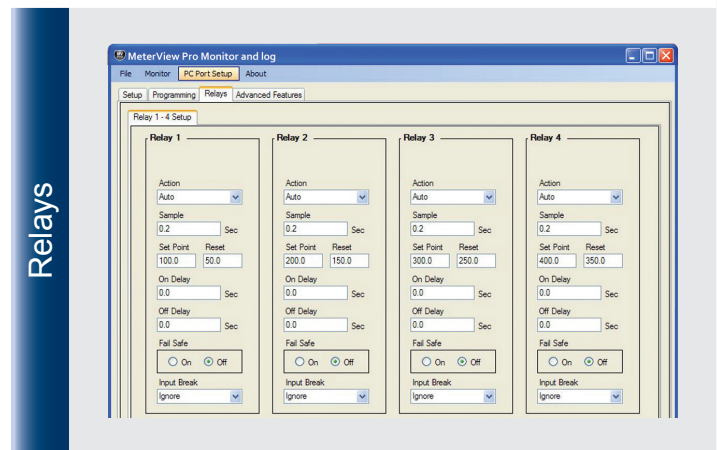
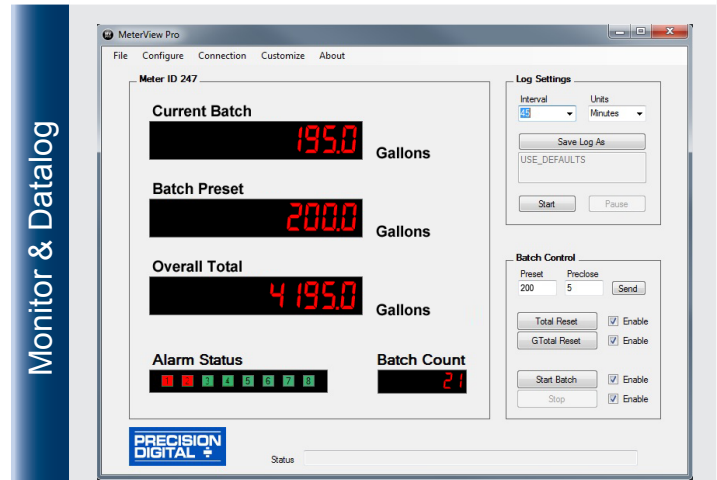

## NEMA 4, NEMA 4X, AND EXPLOSION-PROOF ENCLOSURES

Thermoplastic and stainless steel NEMA 4X, and painted steel NEMA 4 enclosures are available. Also available is the ProtEX-MAX for hazardous area applications requiring explosion-proof enclosures. Visit our website at [www.predig.com](http://www.predig.com) for more information.



**PDA260**  
Stainless Steel



**PDA2811**  
Plastic Low-Cost



**PD8 Series**  
ProtEX-MAX



## PD8-6310-WM DIMENSIONS

Units: Inch (mm)

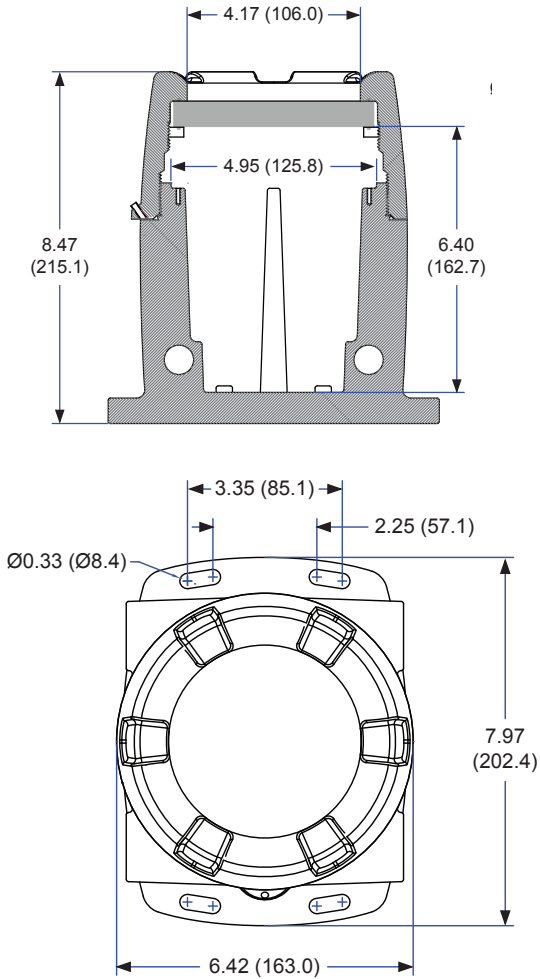

## PD6310-WM DIMENSIONS

Units: Inch (mm)

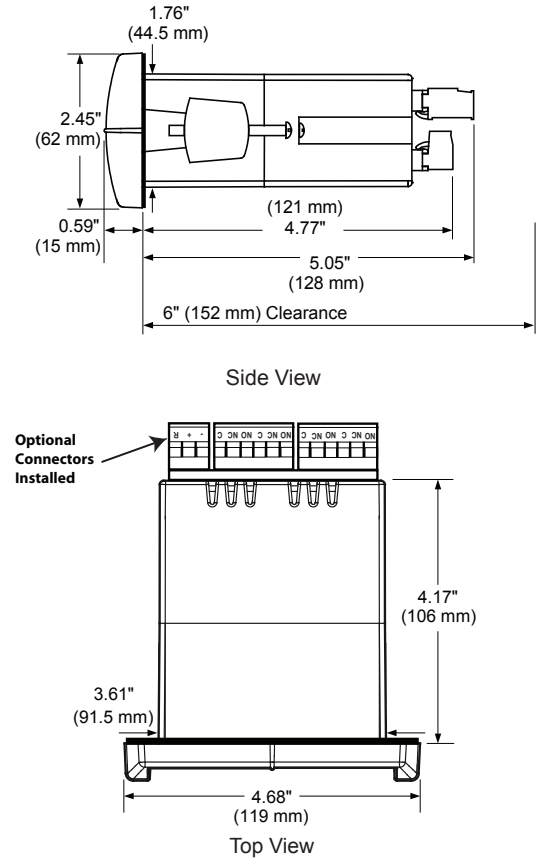

Notes:

1. Panel cutout required: 1.772" x 3.622" (45mm x 92mm)
2. Panel thickness: 0.040 - 0.250" (1.0mm - 6.4mm)
3. Mounting brackets lock in place for easy mounting
4. Clearance: Allow 6" (152 mm) behind the panel

## CONNECTIONS

### PD8-6310-WM Connection Drawing

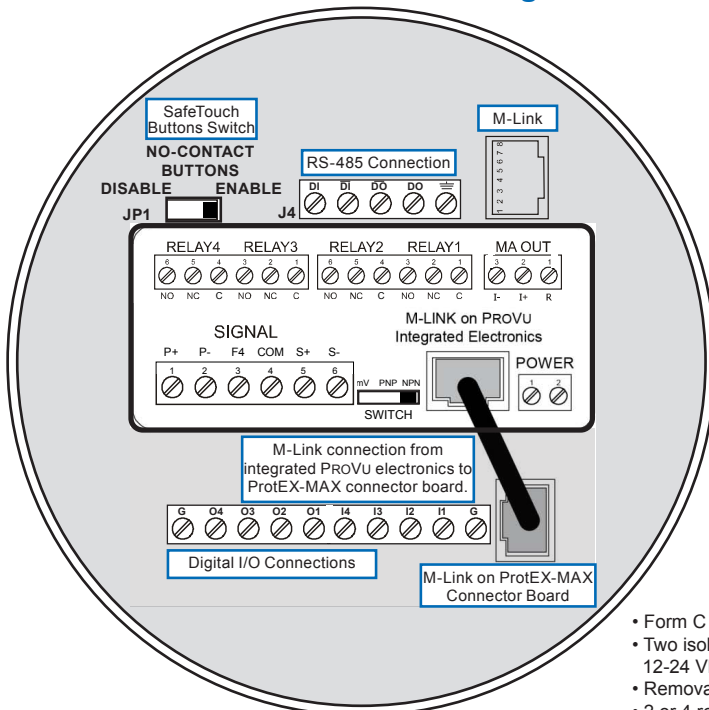

### PD6310-WM Connection Drawing

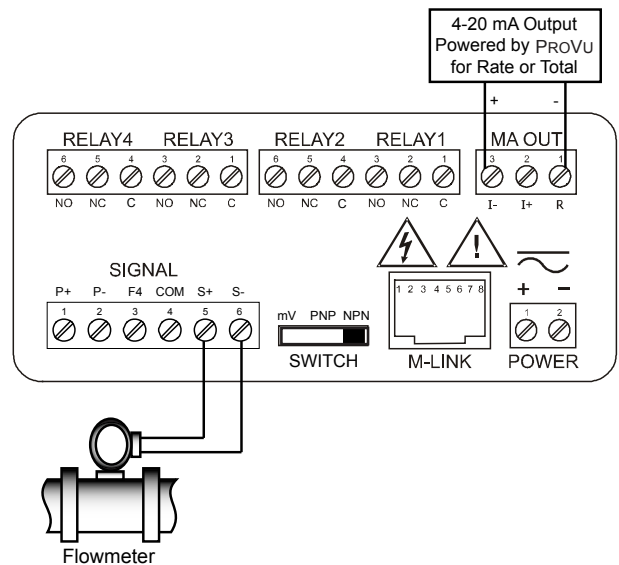

- Form C (SPDT) relays
- Two isolated power supplies available even on 12-24 VDC input power models
- Removable terminal blocks
- 2 or 4 relays + isolated 4-20 mA output option

- Input Power Options: 85-265 VAC or 12-24 VDC
- M-Link for adding expansion modules
- Digital Input (F4) is standard

## SPECIFICATIONS

Except where noted all specifications apply to operation at +25°C.

### General

**Display:** Upper display: 0.60" (15 mm) high. Lower display: 0.46" (12 mm) high. Both are 6 digits (-99999 to 999999), red LEDs, with lead zero blanking.

**Default Display Assignment:** The upper display shows batch total. The lower display shows rate with alternating units, and can be switched to show grand total, batch count, or preset with the STOP key.

**Custom Display Assignment:** The upper and lower displays may be assigned to rate, total, grand total, batch count, preset, set points, units (lower display only), alternating R & T, R & GT, preset & rate, max & min, or a Modbus display register. Any rate/total/grand total display may be programmed to alternate with a custom unit or tag.

**Alternating Display:** Displays alternate every 10 seconds when display is selected or the batch is paused.

**Display Intensity:** Eight user selectable intensity levels

**Display Update Rate:** 5/second (200 ms)

**Overrange:** Display flashes 999999

**Underrange:** Display flashes -99999

**Operating Methods:** Three programmable front panel buttons (default START, BATCH, STOP), digital inputs, PC and MeterView Pro software, and Modbus registers.

**Programming Lockout:** Programming lockout jumper. Seal loop and loop attachment features to prevent access to the lockout jumper.

**F4 Digital Input Contacts:** 3.3 VDC on contact. Connect normally open contacts across F4 to COM.

**F4 Digital Input Logic Levels:** Logic High: 3 to 5 VDC  
Logic Low: 0 to 1.25 VDC

**Noise Filter:** Programmable from 2 to 199 (0 will disable filter)

**Filter Bypass:** Programmable from 0.1 to 99.9% of calibrated span.

**Recalibration:** Recommended at least every 12 months.

**Max/Min Display:** Max (Peak) / min (Valley) readings reached by the process are stored until reset by the user or until power is cycled.

**Password:** Three programmable passwords restrict modification of programmed settings and two prevent resetting the totals.

**Non-Volatile Memory:** All programmed settings are stored in non-volatile memory for a minimum of ten years if power is lost.

**Power Options:** 85-265 VAC 50/60 Hz, 90-265 VDC 20 W max, or 12-24 VDC ±10%, jumper selectable, 15 W max.

**Fuse:** Required external fuse: UL Recognized, 5 A max, slow blow; up to 6 batch controllers may share one 5 A fuse.

**Normal Rejection Mode:** Greater than 60 dB at 50/60 Hz

**Isolation:** 4 kV input/output-to-power line. 500 V input-to-output or output-to-P+ supply.

**Overvoltage Category:** Installation Overvoltage Category II: Local level with smaller transient overvoltages than Installation Overvoltage Category III.

**Connections:** Removable screw terminal blocks accept 12 to 22 AWG wire, RJ45 for external relays, digital I/O, and serial communication adapters.

**Warranty:** 3 years parts & labor

**USB Connection:** Compatibility: USB 2.0 Standard, Compliant.

Connector Type: Micro-B receptacle. Cable: USB A Male to Micro-B Cable. Driver: Microsoft® Windows® XP/Vista/7/8/10. Power: USB Port

### Pulse Input

**Inputs:** Field selectable: Pulse or square wave 0-5 V, 0-12 V, or 0-24 V @ 30 kHz; TTL; open collector 4.7 kΩ pull-up to 5 V @ 30 kHz; NPN or PNP transistor, switch contact 4.7 kΩ pull-up to 5 V @ 40 Hz; coil (sine wave) 40 mVp-p min @ 10 kHz; Modbus PV (Slave)

**Low Voltage Mag Pickup (Isolated):** Sensitivity: 40 mVp-p to 8 Vp-p

**Minimum Input Frequency:** 0.001 Hz - Minimum frequency is dependent on high gate setting.

**Maximum Input Frequency:** 30,000 Hz (10,000 for Low Voltage Mag Pickup)

**Input Impedance:** Pulse input: Greater than 300 kΩ @ 1 kHz. Open collector/switch input: 4.7 kΩ pull-up to 5 V.

**Accuracy:** ±0.03% of calibrated span ±1 count

**Display Update Rate:** Total: 10/sec, Rate: 10/sec to 1/1000 sec

**Temperature Drift:** Rate display is not affected by changes in temperature.

**Multi-Point Linearization:** 2 to 32 points

**Low-Flow Cutoff:** 0-999999 (0 disables cutoff function)

**Decimal Point:** Up to five decimal places or none: dddddd, dddddd, dddddd, dddddd, dddddd, or dddddd.

**Calibration:** May be calibrated using K-factor, scale using internal calibration, or calibrate by applying an external calibration signal.

**K-Factor:** Field programmable K-factor converts input pulses to rate in engineering units. May be programmed from 0.00001 to 999,999 pulses/unit.

**Calibration Range:** Input 1 signal may be set anywhere in the range of the batch controller; input 2 signal may be set anywhere above setting.

**Filter:** Programmable contact de-bounce filter, 40 to 999 Hz maximum input frequency allowed with low speed filter.

**Time Base:** Second, minute, hour, or day

**Low Gate:** 0.1-99.9 seconds; this function determines how often the incoming pulses are calculated and the rate display is updated.

**High Gate:** 2.0-999.9 seconds; this function determines how long to wait for pulses before the display goes to zero. This function is used to display slow pulse rates.

*Note: The combination of the low and high gate functions makes it possible to have a fast display update for fast pulse rates while displaying slow pulse rates, if needed. For example: If the low gate is set to 1.0 second and the high gate to 999.9 second, with a fast pulse rate the display is updated every second; with a slow pulse rate the batch controller is capable of waiting up to 999.9 seconds before calculating the rate, making it possible to display a very slow rate down to 1 pulse/999.9 second (0.001 pulse/second).*

### Batch Controller

**Rate Display Indication:** 0 to 999999, lead zero blanking. "R" LED illuminates while displaying rate.

**Total Displays & Grand Total Overflow:** 0 to 999,999; automatic lead zero blanking. "T" LED is illuminated while displaying batch total and "GT" for grand total. Up to 999,999,999 with total-overflow feature. "oF" is displayed to the left of grand total overflow and ▲ LED is illuminated.

**Batch Total Decimal Point:** Up to five decimal places or none: dddddd, dddddd, dddddd, dddddd, or dddddd.

*Total decimal point is independent of rate decimal point.*

**Totalizer:** Calculates total based on rate and field programmable multiplier to display total in engineering units. Time base must be selected according to the time units in which the rate is displayed.

**Total Conversion Factor:** 0.00001 to 999,999

**Batch Preset:** 0.00001 to 999,999 based on batch total decimal point.

**Automatic Batch Restart Delay:** 00000.1 to 999.9 seconds. The batch will automatically restart after completion of the last batch.

**Grand Total Rollover:** Totalizer rolls over when display exceeds 999,999,999. Relay status reflects the display value.

**Grand Total Alarms:** Up to seven, user selectable under Setup menu.

Any set point can be assigned to grand total and may be programmed anywhere in the range of the batch controller for grand total alarm indication. Note that Relay 1 should always be assigned to batch control (εoεRε).

**Grand Total Reset:** Via front panel button, external contact closure on digital inputs, automatically via user selectable preset value and time delay, or through serial communications.

**Grand Total Reset Password:** A grand total password may be entered to prevent resetting the grand total from the front panel.

**Non-Resettable Grand Total:** The grand total can be programmed as a non-resettable total by entering the password "050873".

*Caution: Once the Grand Total has been programmed as "non-resettable" the feature cannot be disabled.*

### Relays

**Rating:** 2 or 4 SPDT (Form C) internal and/or 4 SPST (Form A) external; rated 3 A @ 30 VDC and 125/250 VAC resistive load; 1/14 HP (≈ 50 W) @ 125/250 VAC for inductive loads

**Noise Suppression:** Noise suppression is recommended for each relay contact switching inductive loads.

**Relay Assignment:** Relays may be assigned to batch control, sampling, rate, or grand total alarms.

**Preclose:** 0-100% of batch size, individually user programmable for each additional batch control relay beyond the first.

**Alarm Deadband:** 0-100% of span, user programmable

**High or Low Alarm:** User may program any alarm for high or low trip point. Unused alarm LEDs and relays may be disabled (turned off).

**Batching Relay Operation:** Single or (2 to 8) multi-relay batching with optional preclose for multi-stage operation. Each additional relay may be programmed with an individual preclose value.

**Alarm Relay Operation:** Automatic (non-latching), latching (requires manual acknowledge), sampling (based on rate or grand total), pump alternation control (2 to 8 relays), off (disable unused relays), and manual on/off control mode. Alarms are active only when the batch is running.

**Alarm Relay Reset:** User selectable via front buttons, digital inputs, or PC

1. Automatic reset only (non-latching), when input passes the reset point or total is reset to zero.

2. Manual reset only, when batch is stopped (latching).

3. Manual reset only after alarm condition has cleared (latching)

*Note: Front panel button or digital input may be assigned to acknowledge relays programmed for manual reset. This replaces one of the standard batch control function keys. Only the PAUSE/STOP key function is possible during a batch process, so manual reset may only be done when the batch controller is in STOP mode.*

**Deadband:** 0-100% of span, user programmable

**Time Delay:** 0 to 999.9 seconds, on & off relay time delays. Programmable and independent for each relay.

**Fail-Safe Operation:** Programmable and independent for each relay.

*Note: Relay coil is energized in non-alarm condition. In case of power failure, relay will go to alarm state.*

**Auto Initialization:** When power is applied, relays will reflect the state of the input. Alarms are active only when the batch is running.

## Isolated 4-20 mA Transmitter Output

**Output Source:** Rate/process, total, grand total, max, min, set points 1-8, manual control setting, or Modbus input

**Scaling Range:** 1.000 to 23.000 mA for any display range

**Calibration:** Factory calibrated: 4.000 to 20.000 = 4-20 mA output

**Analog Output Programming:** 23.000 mA maximum for all parameters: Overrange, underrange, max, min, and break

**Accuracy:** ± 0.1% FS ± 0.004 mA

**Temperature Drift:** 0.4 µA/°C max from 0 to 65°C ambient,

0.8 µA/°C max from -40 to 0°C ambient

*Note: Analog output drift is separate from input drift.*

**Isolated Transmitter Power Supply:** Terminals I+ & R: 24 VDC ± 10%. Isolated from the input at >500 V. May be used to power the 4-20 mA output or other devices.

**External Loop Power Supply:** 35 VDC maximum

**Output Loop Resistance:**

Power supply	Minimum	Maximum
24 VDC	10 Ω	700 Ω
35 VDC (external)	100 Ω	1200 Ω

## Serial Communications

**Protocol:** Modbus RTU

**Batch controller Address/Slave ID:** 1 - 247

**Baud Rate:** 300 - 19,200 bps

**Transmit Time Delay:** Programmable between 0 and 199 ms or transmitter always on for RS-422 communication

**Data:** 8 bit (1 start bit, 1 or 2 stop bits)

**Parity:** Even, odd, or none with 1 or 2 stop bits

**Byte-to-Byte Timeout:** 0.01 - 2.54 seconds

**Turn Around Delay:** Less than 2 ms (fixed)

*Note: Refer to the ProVu Modbus Register Tables located at [www.predig.com](http://www.predig.com) for details.*

## PD6310-WM Specifications

**Enclosure:** 1/8 DIN, high impact plastic, UL 94V-0, color: black

**Front Panel:** UL Type 4X, NEMA 4X/IP65; panel gasket provided

**Programming Methods:** Four front panel buttons, digital inputs, PC and MeterView Pro software, Modbus registers, or cloning using Copy function.

**Isolated Transmitter Power Supply:** Terminals P+ & P-: 24 VDC ± 10%. Internally selectable jumper for 24, 10, or 5 VDC supply.

85-265 VAC models rated @ 200 mA max, 12-24 VDC powered models rated @ 100 mA max, @ 50 mA max for 5 or 10 VDC supply.

**Environmental:** Operating temperature range: -40 to 65°C. Storage temperature range: -40 to 85°C. Relative humidity: 0 to 90% non-condensing.

**Mounting:** 1/8 DIN panel cutout required: 3.622" x 1.772" (92 mm x 45 mm).

**Dimensions:** 4.68" x 2.45" x 5.64" (119 mm x 62 mm x 143 mm) (W x H x D)

**Weight:** 9.5 oz. (269 g)

**Low Voltage Directive:** EN 61010-1:2001

Safety requirements for measurement, control, and laboratory use

**UL & cUL Listed:** USA & Canada UL 508 Industrial Control Equipment

**UL File Number:** E160849

## PD8-6310-WM Specifications

**Programming Methods:** Four front panel buttons, SafeTouch buttons, digital inputs, PC and MeterView Pro software, Modbus registers, or cloning using Copy function.

**Isolated Transmitter Power Supply:** Terminals P+ & P-: 24 VDC ± 10%. Internally selectable jumper for 24, 10, or 5 VDC supply.

All models transmitter supply rated @ 25mA max.

**Max Power Dissipation:** PD8 Series: Maximum power dissipation limited to 15.1 W.

**Digital Inputs:** Four. High: 3 to 5 VDC, Low: 0 to 0.4 VDC, Sink: 1.5 mA max.

**Digital Outputs:** Four. High: 4.75 VDC, Low: 0 to 0.4 VDC, Source: 15 mA max.

**+5V Terminal:** +5 VDC terminal for use with digital inputs only.

**Serial Communications:** RS-485 half-duplex (3-wire) connection

**Environmental:** T6 Class operating temperature range Ta = -55 to 60°C

T5 Class operating temperature range Ta = -55 to 65°C. Storage

temperature range: -55 to 85°C (-67 to 185°F). Relative humidity: 0 to 90% non-condensing.

**Mounting:** Two built-in mounting flanges for wall or pipe mounting

**Dimensions:** 6.42" x 7.97" x 8.47" (163 mm x 202 mm x 215 mm) (W x H x D)

**Weight:** Aluminum: 14.7 lbs (6.67 kg) Stainless Steel: 23.5 lbs (10.66 kg)

**Enclosure**

**Material:** AL Models: ASTM A413 LM6 die-cast aluminum, copper-free, enamel coated. SS Models: ASTM A743 CF8M investment-cast 316 stainless steel

**Gasket:** Fluoroelastomer

**Rating:** NEMA 4X, IP68 Explosion-proof

**Color:** AL: Blue. SS: Silver.

**Window:** Borosilicate glass

**Conduits:** Four 3/4" NPT threaded conduit openings

**Conduit Stopping Plugs:** Sold separately

**Flanges:** Two built-in flanges for wall and pipe mounting.

**Tamper-Proof Seal:** Cover may be secured with tamper-proof seal.

**Overall Dimensions:** 6.42" x 7.97" x 8.47" (W x H x D) (163 mm x 202 mm x 215 mm)

**Weight:** AL: 14.7 lbs (6.67 kg). SS: 23.5 lbs (10.66 kg).

**ATEX:** Flameproof protection

⊕ II 2 G D

Ex db IIC Gb

Ex tb IIIC Db

IP66/IP68

Tamb: -55°C to +85°C

Certificate Number: Sira 19ATEX1252U

**IECEx:** Flameproof and dust protection

Ex db IIC Gb

Ex tb IIIC Db

IP66/IP68

Tamb: -55°C to +85°C

Certificate Number: IECEx SIR 19.0075U

**CSA:**

Class I, Division 1, Groups A, B, C, D

Class II, Division 1, Group E, F, G

Class III

Ex db IIC Gb

Ex tb IIIC Db

Class I, Zone 1, AEx db IIC Gb

Zone 21, AEx tb IIIC Db

IP66/IP68/TYPE 4X

Tamb: -55°C to +85°C

Certificate Number: CSA19.80011200U

**UL:**

Class I, Division 1, Groups A, B, C, D

Class II, Division 1, Groups E, F, G

Class III

Class I, Zone 1, AEx db IIC Gb

Zone 21, AEx tb IIIC Db

Ex db IIC Gb

Ex tb IIIC Db

IP66/IP68/TYPE 4X

Tamb: -55°C to +85°C

Certificate Number: E518920

**Note: The above approvals are for the enclosure only. See next page for approvals on the entire instrument.**

## General Compliance Information

### Electromagnetic Compatibility

#### Emissions

EN 55022

Class A ITE emissions requirements

**Radiated Emissions:** Class A

**AC Mains Conducted Emissions:** Class A

#### Immunity

EN 61326-1

Measurement, control, and laboratory equipment

EN 61000-6-2

EMC heavy industrial generic immunity standard

**RFI - Amplitude Modulated:** 80 -1000 MHz 10 V/m 80% AM (1 kHz)

1.4 - 2.0 GHz 3 V/m 80% AM (1 kHz)

2.0 - 2.7 GHz 1 V/m 80% AM (1 kHz)

**Electrical Fast Transients:** ±2kV AC mains, ±1kV other

**Electrostatic Discharge:** ±4kV contact, ±8kV air

**RFI - Conducted:** 10V, 0.15-80 MHz, 1kHz 80% AM

**AC Surge:** ±2kV Common, ±1kV Differential

**Surge:** 1KV (CM)

**Power-Frequency Magnetic Field:** 30 A/m 70%V for 0.5 period

**Voltage Dips:** 40%V for 5 & 50 periods

70%V for 25 periods

Voltage Interruptions: <5%V for 250 periods

**Note:** Testing was conducted on meters with cable shields grounded at the point of entry representing installations designed to optimize EMC performance.

## Product Ratings and Approvals

**CSA:** Class I, Division 1, Groups B, C, D  
Class II, Division 1, Groups E, F, G  
Class III, Division 1, T5  
Class III, Division 1, T6 (Ta max = 60°C)  
Ex db IIC T5  
Ex db IIC T6 (Ta max = 60°C)  
Ex tb IIIC T90°C  
Ta = -55°C to +65°C  
Enclosure: Type 4X & IP66 / IP68  
CSA Certificate: CSA 12 2531731

**ATEX:** Ⓢ II 2 G D  
Ex db IIC T\* Gb  
Ex tb IIIC T90°C Db IP68  
Ta = -55°C to +\*°C  
\*T6 = -55°C to +60°C  
\*T5 = -55°C to +65°C  
Certificate Number: Sira 12ATEX1182X

**IECEx:** Ex db IIC T\* Gb  
Ex tb IIIC T90°C Db IP68  
Ta = -55°C to +\*°C  
\*T6 = -55°C to +60°C  
\*T5 = -55°C to +65°C  
Certificate Number: IECEx SIR 12.0073X

### ATEX/IECEx Specific Conditions of Use:

- The equipment label and epoxy coating may generate an ignition-capable level of electrostatic charges under certain extreme conditions. The user should ensure that the equipment is not installed in a location where it may be subjected to external conditions (such as high-pressure steam) which might cause a build-up of electrostatic charges on non-conducting surfaces. Additionally, cleaning of the equipment should be done only with a damp cloth.
- Flameproof joints are not intended to be repaired.
- All entry closure devices shall be suitably certified as "Ex d", "Ex t" and "IP66/68" as applicable. Suitable thread sealing compound (non-setting, non-insulating, non-corrosive, not solvent based, suitable for the ambient rating) must be used at the NPT conduit entries to achieve the IPx8 rating while maintaining the Ex protection concept.

### Year of Construction

This information is contained within the serial number with the first four digits representing the year and month in the YYMM format.

### For European Community

The ProtEX-MAX must be installed in accordance with the ATEX directive 2014/34/EU, the product manual, and the product certificate Sira 12ATEX1182X.

## NTEP Weights and Measures Certification

**Certificate Number:** 14-061

**Definition:** Register for Meter

Stationary Wholesale Liquid Register/Batch controller Digital Electronic Model: PD63XX Series and PD8-63XX Series

**Evaluation Criteria:** NIST Handbook 44 Specifications, Tolerances, and Other Technical Requirements for Weighing and Measuring Devices, 2014 Edition. NCWM Publication 14 Measuring Devices, 2014 Edition.

*National Conference on Weights and Measures (NCWM) National Type Evaluation Program (NTEP) Certificate of Conformance available at [www.predig.com](http://www.predig.com).*

## MeterView Pro Specifications

**System Requirements:** Windows® 2000/XP/Vista/7/8/10

**Communications:** RS-232 Adapter or RS-422/485 Adapter

**Meter Address:** 1 - 247

**Reports:** Data logging: Save as CSV file format

Configuration: Save as PDC file format or print configuration

**Baud Rate:** 300 - 19,200 bps

**Configuration:** One meter at a time

**Protocol:** Modbus RTU (requires PROVU firmware version 2.0 or higher)

*Note: Windows 32-bit and 64-bit operating systems*

## Securing the Unit

Once the operator has completed programming the PD6310-WM for the desired application, it is time to secure the unit. First, power down the meter and remove all connectors. Unscrew the back cover and slide it back about 1 inch. Then, configure the JP1 jumper, located behind the input signal connector, for the desired programming lockout operation (On or Off), as shown below in **Figure 1**. Return the back cover to its normal position.

## NTEP Wire Security Seal Installation

Once the Lockout Jumper has been installed, the operator can install the wire security seal to complete the Lockout Procedure. Be sure the security seal mounting bracket (identified by the wire loop pass-through located next to the mounting screw) is located on the side of the case with the wire loop pass-through holes. Pass the wire security loop through the wire loop pass-through holes on the rear portion of the batch controller housing, then through the pass-through holes on the security bracket (next to the mounting screw). With the wire loop through the rear of the case and the mounting bracket, pass the loop back through the crimp seal end. Tighten the loop such that it will prevent the rear of the case from being removed while the loop is in place. The wire loop may now be tagged, crimped, and sealed to mechanically secure both the rear case and the programming lockout jumper contained within. Proper Wire Security Loop installation can be seen in **Figure 2**.

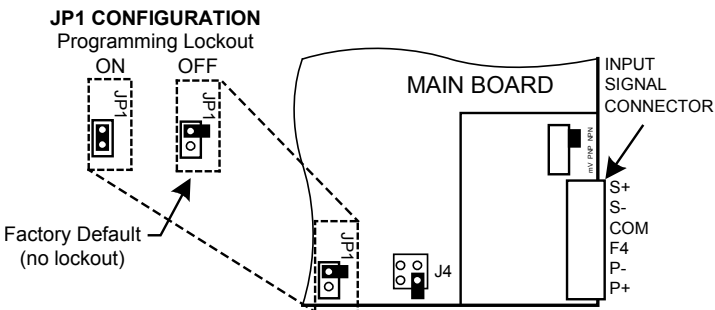

**Figure 1. Programming NTEP Lockout Jumper**

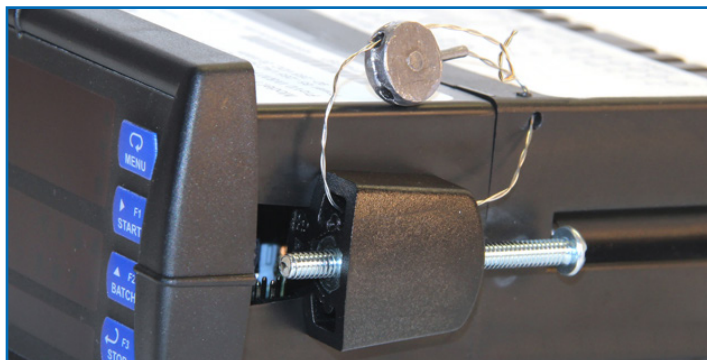

**Figure 2. Proper Wire Security Loop Installation**

## ORDERING INFORMATION

ProVu® PD6310-WM Pulse Input Batch Controller		
85-265 VAC Model	12-24 VDC Model	Options Installed
PD6310-6H2-WM	PD6310-7H2-WM	2 Relays
PD6310-6H4-WM	PD6310-7H4-WM	4 Relays
PD6310-6H5-WM	PD6310-7H5-WM	2 Relays & 4-20 mA Output
PD6310-6H7-WM	PD6310-7H7-WM	4 Relays & 4-20 mA Output

**Note:** 24 V flowmeter power supply standard on all models.

PD8-6310-WM Pulse Input Batch Controller Aluminum Enclosure		
85-265 VAC Model	12-24 VDC Model	Options Installed
PD8-6310-6H7-WM	PD8-6310-7H7-WM	4 Relays & 4-20 mA Output

**Note:** 24 V flowmeter power supply standard on all models.

PD8-6310-WM Pulse Input Batch Controller Stainless Steel Enclosure		
85-265 VAC Model	12-24 VDC Model	Options Installed
PD8-6310-6H7-WM-SS	PD8-6310-7H7-WM-SS	4 Relays & 4-20 mA Output

**Note:** 24 V flowmeter power supply standard on all models.

Accessories	
Model	Description
PDA1002	DIN Rail Mounting Kit for Two Expansion Modules*
PDA1004	4-Relay Expansion Module*
PDA1044	4 Digital Inputs & 4 Digital Outputs Module*
PDA1232	RS-232 Serial Adapter*
PDA1485	RS-422/485 Serial Adapter*
PDA7485-I	RS-232 to RS-422/485 Isolated Converter
PDA7485-N	RS-232 to RS-422/485 Non-Isolated Converter
PDA8232-N	USB to RS-232 Non-Isolated Converter
PDA8485-I	USB to RS-422/485 Isolated Converter
PDA8485-N	USB to RS-422/485 Non-Isolated Converter
PDX6901	Suppressor (snubber): 0.01 µF/470 Ω, 250 VAC*
PDAPLUG75	3/4" NPT 316 Stainless Steel Stopping Plug with Approvals**
PDA6848	Pipe Mounting Kit Zinc Plated**
PDA6848-SS	Pipe Mounting Kit Stainless Steel**

\*For use with the ProVu Series PD6310-WM only.

\*\*For use with the ProtEX-MAX Series PD8-6310-WM only.

### WARNING

Cancer and Reproductive Harm - [www.P65Warnings.ca.gov](http://www.P65Warnings.ca.gov)

### Disclaimer

The information contained in this document is subject to change without notice. Precision Digital Corporation makes no representations or warranties with respect to the contents hereof, and specifically disclaims any implied warranties of merchantability or fitness for a particular purpose.

©2023 Precision Digital Corporation. All rights reserved.